

# INSPIRON™

## SETUP GUIDE







# INSPIRON™

## SETUP GUIDE

Model PP38L

## Notes, Notices, and Cautions

-  **NOTE:** A NOTE indicates important information that helps you make better use of your computer.
-  **NOTICE:** A NOTICE indicates either potential damage to hardware or loss of data and tells you how to avoid the problem.
-  **CAUTION:** A CAUTION indicates a potential for property damage, personal injury, or death.

---

**Information in this document is subject to change without notice.**

**© 2008 Dell Inc. All rights reserved.**

Reproduction of these materials in any manner whatsoever without the written permission of Dell Inc. is strictly forbidden.

Trademarks used in this text: *Dell*, the *DELL* logo, *Inspiron*, *YOURS IS HERE*, and *DellConnect* are trademarks of Dell Inc.; *Intel*, *Celeron*, and *Centrino* are registered trademarks and *Core* is a trademark of Intel Corporation in the U.S. and other countries; *Microsoft*, *Windows*, and *Windows Vista* are either trademarks or registered trademarks of Microsoft Corporation in the United States and/or other countries.; *Bluetooth* is a registered trademark owned by Bluetooth SIG, Inc. and is used by Dell under license.

Other trademarks and trade names may be used in this document to refer to either the entities claiming the marks and names or their products. Dell Inc. disclaims any proprietary interest in trademarks and trade names other than its own.

**September 2008**

**P/N Y727H**

**Rev. A01**

# Contents

<b>About Your Computer</b> .....	<b>5</b>	<b>Solving Problems</b> .....	<b>18</b>
Connect the AC Adapter .....	5	Network Problems .....	18
Connect the Network Cable (optional) .....	6	Power Problems .....	19
Press the Power Button .....	6	Memory Problems .....	20
Windows Vista® Setup .....	6	Lockups and Software Problems .....	20
Connect to the Internet (Optional) .....	6	Dell Support Center .....	23
<b>Using Your Inspiron Laptop</b> .....	<b>9</b>	<b>Using Support Tools</b> .....	<b>23</b>
Device Status Lights .....	9	System Messages .....	24
Keyboard Status Lights .....	10	Hardware Troubleshooter .....	25
Left Side Features .....	12	Dell Diagnostics .....	26
Computer Base and Display Features .....	14	<b>Restoring Your Operating System</b> .....	<b>28</b>
Removing and Replacing the Battery .....	15	Windows Operating System	
Software Features .....	16	Reinstallation .....	28

<b>Getting Help</b> .....	<b>30</b>
Technical Support and Customer Service .....	31
Online Services .....	31
AutoTech Service.....	32
Product Information.....	32
Before You Call.....	33
Contacting Dell.....	34
<b>Finding More Information and Resources</b> .....	<b>36</b>
<b>Basic Specifications</b> .....	<b>38</b>
<b>Index</b> .....	<b>45</b>

# About Your Computer

This section provides information about setting up your Inspiron 1410 laptop and connecting peripherals.

## Before Setting Up Your Computer

When positioning your computer, ensure that you allow easy access to a power source, adequate ventilation, and a level surface to place your computer.

Restricting airflow around your Inspiron laptop may cause it to overheat. To prevent overheating ensure that you leave at least 10.2 cm (4 in) at the back of the computer and a minimum of 5.1 cm (2 in) on all other sides. You should never put your computer in an enclosed space, such as a cabinet or drawer when it is powered on.

➔ **NOTICE:** Placing or stacking heavy or sharp objects on the computer may result in permanent damage to the computer.

## Connect the AC Adapter

Connect the AC adapter to the computer and then plug it into a wall outlet or surge protector.



**⚠ CAUTION:** The AC adapter works with electrical outlets worldwide. However, power connectors and power strips vary among countries. Using an incompatible cable or improperly connecting the cable to a power strip or electrical outlet may cause fire or equipment damage.

### Connect the Network Cable (optional)

To use a wired network connection, plug in the network cable.



### Press the Power Button



### Windows Vista® Setup

If you selected Windows Vista operating system while ordering, your Dell computer is preconfigured with Windows Vista. To set up Windows Vista for the first time, follow the instructions on the screen. These steps are mandatory and may take up to 15 minutes to complete. The screens will take you through several procedures including accepting license agreements, setting preferences and setting up an Internet connection.

- ⚠ **NOTICE:** Do not interrupt the operating system's setup process. Doing so may render your computer unusable.

### Connect to the Internet (Optional)

- ✍ **NOTE:** ISPs (Internet Service Providers) and ISP offerings vary by country.
- ✍ **NOTE:** The instructions in this section are applicable for Windows only.



To connect to the Internet, you need an external modem or network connection and an Internet service provider (ISP).

 **NOTE:** If an external USB modem or WLAN adapter is not a part of your original order, you can purchase one from the Dell website at [www.dell.com](http://www.dell.com).

 **NOTE:** If you cannot connect to the Internet but have successfully connected in the past, the ISP might have a service outage. Contact your ISP to check the service status, or try connecting again later.

 **NOTE:** Have your ISP information ready. If you do not have an ISP, then connect to the Internet wizard can help you get one.

### Setting Up a Wired Internet Connection

If you are using a dial-up connection, connect the telephone line to the external USB modem (optional) and to the telephone wall jack before you set up your Internet connection. If you are using a DSL or cable/satellite modem

connection, contact your ISP or cellular telephone service for setup instructions.

### Setting Up a Wireless Connection

Before you can use your wireless Internet connection, you need to connect to your wireless router. To set up your connection to a wireless router:

1. Save and close any open files, and exit any open programs.
2. Click **Start**  → **Connect To**.
3. Follow the instructions on the screen to complete the setup.

### Setting Up Your Internet Connection

 **NOTE:** If you cannot connect to the Internet but have successfully connected in the past, the ISP might have a service outage. Contact your ISP to check the service status, or try connecting again later.

## About Your Computer

 **NOTE:** Have your ISP information ready. If you do not have an ISP, the Connect to the Internet wizard can help you get one.

1. Save and close any open files, and exit any open programs.
2. Click **Start**  → **Control Panel**.
3. Under **Network and Internet**, click **Connect to the Internet**.

The **Connect to the Internet** window appears.

4. Click either **Broadband (PPPoE)** or **Dial-up**, depending on how you want to connect:
  - a. Choose **Broadband** if you use a DSL, satellite modem, cable TV modem, or Bluetooth® wireless technology connection.
  - b. Choose **Dial-up** if you use an optional USB dial-up modem or ISDN.

 **NOTE:** If you do not know which type of connection to select, click **Help me choose** or contact your ISP.

5. Follow the instructions on the screen and use the setup information provided by your ISP to complete the setup.

### Transferring Information to a New Computer

1. Click the **Windows Vista Start** button , and then click **Transfer files and settings** → **Start Windows Easy Transfer**.
2. In the **User Account Control** dialog box, click **Continue**.
3. Click **Start a new transfer** or **Continue a transfer in progress**.
4. Follow the instructions provided on the screen by the **Windows Easy Transfer** wizard.



# Using Your Inspiron Laptop

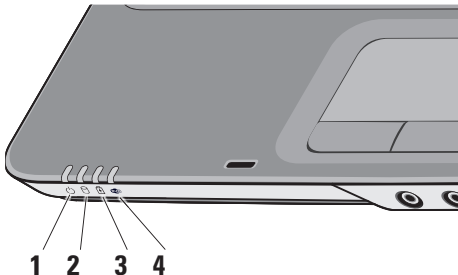

Your Inspiron 1410 has several indicators, buttons, and features that provide information at-a-glance and time-saving shortcuts for common tasks.

## Device Status Lights

The lights located on the palm rest towards the front of the computer indicate the following:







-  **Power light** – Turns on when you turn on the computer, and blinks when the computer is in a power management mode.
-  **Hard drive activity light** – Turns on when the computer reads or writes data. A flashing light indicates hard drive activity.
 

 **NOTE:** To avoid loss of data, never turn off the computer while the hard drive activity light is flashing.
-  **Battery status light** – Turns on steadily or blinks to indicate battery charge status
-  **WiFi status light** – Turns on when wireless networking is enabled.

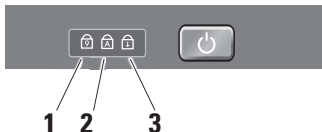
### Keyboard Status Lights

The lights located above the keyboard indicate the following:



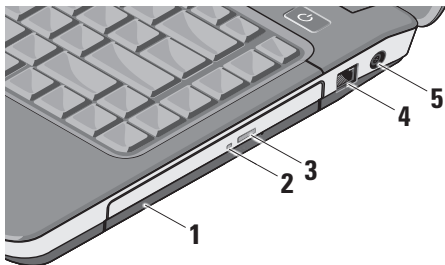

-  **Num Lock light** – Turns on when the numeric keypad (**Num Lock** key) is enabled.
-  **Caps Lock light** – Turns on when the uppercase letter (**Caps Lock** key) is enabled.
-  **Scroll Lock light** – Turns on when the scroll lock function is enabled.

## Right Side Features



- 1 **Optical drive** – Plays or burns CDs and DVDs. Ensure that the side with print or writing is facing upward when inserting discs.
- 2 **Optical drive light** – Blinks when you press the optical drive eject button or when you insert a disc and it is being read.
- 3 **Optical drive eject button** – Opens the optical drive.

- 4  **Modem Connector** – Connects the telephone line to the modem connector. For information on using the modem, see the online modem documentation supplied with your computer.
- 5  **AC Adapter Connector** – Attaches an AC adapter to the computer. The AC adapter converts AC power to the DC power required by the computer. You can connect the AC adapter with your computer turned on or off.

## Left Side Features

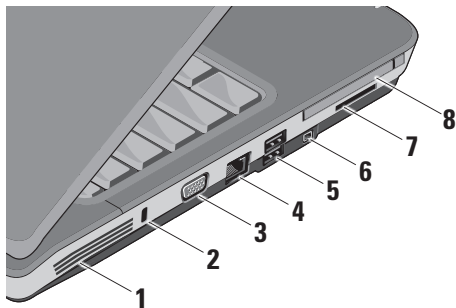

- 1 Air vents** – The computer uses an internal fan to create airflow through the vents, which prevents the computer from overheating. The fan automatically turns on when the computer gets hot. Fan noise is normal and does not indicate a problem with the fan or the computer.

**⚠ CAUTION:** Do not block, push objects into, or allow dust to accumulate in the air vents. Do not store your Dell™ computer in a low-airflow environment, such as a closed briefcase, while it is running. Restricting the airflow can damage the computer or cause a fire. The computer turns on the fan when the computer gets hot. Fan noise is normal and does not indicate a problem with the fan or the computer.

- 2 Security cable slot** – Attaches a commercially available antitheft device to the computer.

**🔑 NOTE:** Before you buy an antitheft device, ensure that it works with the security cable slot on your computer.

- 3  VGA connector** – Connects to a monitor or projector.

- 4  **Network connector** – Connects the computer to a network. The two lights next to the connector indicate status and activity for wired network connections.

For information on using the network adapter, see the device user's guide supplied with your computer.

- 5  **USB 2.0 connectors (2)** – Connect to USB devices, such as a mouse, keyboard, printer, external drive, or MP3 player.
- 6 **IEEE 1394a connector**– Connects devices supporting IEEE 1394a high-speed transfer rates, such as some digital video cameras.



- 7 **3-in-1 media card reader** – Provides a fast and convenient way to view and share digital photos, music, videos, and documents stored on the following digital memory cards:

- Secure Digital (SD) memory card
- Secure Digital High Capacity (SDHC) card
- Multimedia Card (MMC)

- 8 **PC Card Slot** – Supports one PC Card, such as a modem or network adapter. The computer ships with a blank installed in the slot to prevent foreign matter from entering the computer interior when a card is not installed.

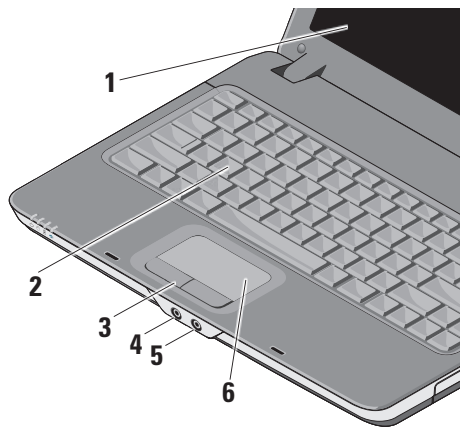

## Computer Base and Display Features



- 1 Display** – Your display can vary based on your selection you made while purchasing your computer. For more information about displays, see the *Dell Technology Guide*.
- 2 Keyboard** – The settings for this keyboard can be personalized by using the system setting utility.
- 3 Touch pad buttons** – Provide left- and right-click functions like those on a mouse.
- 4  Audio Out/ Headphone connector** – Connects to a pair of headphones, or sends audio to a powered speaker or sound system.
- 5  Audio In/ Microphone connector** – Connects to a microphone or input signal for use with audio programs.
- 6 Touch pad** – Provides the functionality of a mouse to move the cursor, drag or move selected items, and left-click by tapping the surface.



## Removing and Replacing the Battery

-  **CAUTION:** Before you begin any of the procedures in this section, follow the safety instructions that shipped with your computer.
-  **CAUTION:** Using an incompatible battery may increase the risk of fire or explosion. Replace the battery only with a compatible battery purchased from Dell. The battery is designed to work with your Dell™ computer. Do not use a battery from other computers with your computer.
-  **CAUTION:** Before removing or replacing the battery, turn off the computer, disconnect the AC adapter from the electrical outlet and the computer, disconnect the modem from the wall connector and computer, and remove any other external cables from the computer.

To remove the battery:

1. Ensure that the computer is turned off.
2. Slide the two latch releases on the bottom of the computer, and then remove the battery from the bay.

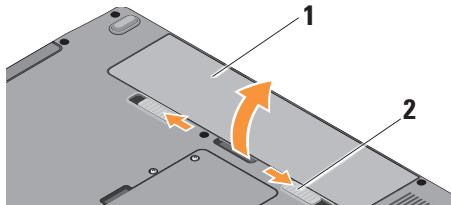

- 1 Battery
- 2 Battery release latch (2)

To replace the battery, slide it into the bay until it clicks into place.

### Software Features

 **NOTE:** For more information about the features described in this section, see the *Dell Technology Guide* on your hard drive or on the Dell Support website at [support.dell.com](http://support.dell.com).

 **NOTE:** The instructions in this section are applicable for Windows only.

### Productivity and Communication

You can use your computer to create presentations, brochures, greeting cards, fliers, and spreadsheets depending on the applications installed in your computer. Check your purchase order for software installed on your computer.

After connecting to the Internet, you can access websites, setup an e-mail account, upload and download files, and so on.

### Entertainment and Multimedia

You can use your computer to watch videos, play games, listen to music and internet radio stations.

### Customizing the Desktop

You can customize your desktop to change the appearance, resolution, wallpaper, screensaver, and so on by accessing the **Personalize appearance and sounds** window.

To access the display properties window:

1. Right-click an open area of the desktop.
2. Click **Personalize**, to open the **Personalize appearance and sounds** window and learn more about your customization options.

### Customizing Your Energy Settings

You can use the power options in your operating system to configure the power settings on your computer.

Microsoft® Windows Vista® provides three default options:

- **Balanced** — This power option offers full performance when you need it and saves power during periods of inactivity.
- **Power saver** — This power option saves power on your computer by reducing system performance to maximize the life of the computer and by reducing the amount of energy consumed by your computer over its lifetime.
- **High performance** — This power option provides the highest level of system performance on your computer by adapting processor speed to your activity and by maximizing system performance.

## Backing Up Your Data

It is recommended that you periodically back up files and folders on your computer.

To back up files:

1. Click **Start**  → **Control Panel** → **System and Maintenance** → **Welcome Center** → **Transfer files and settings**.
2. Click **Back up files** or **Back up computer**.
3. Click **Continue on Your User Account Control** dialog box and follow the instructions in the Back up Files wizard.

# Solving Problems

This section provides troubleshooting information for your computer. If you can not solve your problem using the following guidelines, see “Using Support Tools” on page 23 or see “Contacting Dell” on page 34.

## Network Problems

### Wireless Connections

#### If the wireless network connection is lost

— Interference may be blocking or interrupting your wireless connection. Try moving the computer closer to your wireless router.

### Wired Connections

**If the network connection is lost** — The cable is loose or damaged.

- Check the cable to ensure it is plugged in and not damaged.

The link integrity light on the integrated network connector lets you verify that your connection is working and provides information on the status:

- Green — A good connection exists between a 10-Mbps network and the computer.
- Orange — A good connection exists between a 100-Mbps network and the computer.
- Off — The computer is not detecting a physical connection to the network.



**NOTE:** The link integrity light on the network connector is only for the wired cable connection. The link integrity light does not provide status for wireless connections.

## Power Problems

**If the power light is off** — The computer is either turned off or is not receiving power.

- Reseat the power cable into both the power connector on the computer and the electrical outlet.
- If the computer is plugged into a power strip, ensure that the power strip is plugged into an electrical outlet and that the power strip is turned on. Also bypass power protection devices, power strips, and power extension cables to verify that the computer turns on properly.
- Ensure that the electrical outlet is working by testing it with another device, such as a lamp.
- Check the AC adapter cable connections. If the AC adapter has a light, ensure that the light on the AC adapter is on.

**If the power light is solid white and the computer is not responding** — The display may not be connected or powered on. Ensure that the display is properly connected and then turn it off and then back on.

**If the power light is blinking white** — The computer is in standby mode. Press a key on the keyboard, move the pointer using the touch pad or a connected mouse, or press the power button to resume normal operation.

**If you encounter interference that hinders reception on your computer** — An unwanted signal is creating interference by interrupting or blocking other signals. Some possible causes of interference are:

- Power, keyboard, and mouse extension cables.
- Too many devices connected to a power strip.
- Multiple power strips connected to the same electrical outlet.

### Memory Problems

#### If you receive an insufficient memory message—

- Save and close any open files and exit any open programs you are not using to see if that resolves the problem.
- See the software documentation for minimum memory requirements. If necessary, install additional memory (See the *Service Manual* on the Dell Support website at [support.dell.com](http://support.dell.com)).
- Reseat the memory modules (See the *Service Manual* on the Dell Support website at [support.dell.com](http://support.dell.com)) to ensure that your computer is successfully communicating with the memory.

#### If you experience other memory problems —

- Ensure that you are following the memory installation guidelines (see the *Service Manual* on the Dell Support website at [support.dell.com](http://support.dell.com)).

- Check if the memory module is compatible with your computer. Your computer supports DDR2 memory. For more information about the type of memory supported by your computer, see “Basic Specifications” on page 38.
- Run the Dell Diagnostics (see “Dell Diagnostics” on page 25).
- Reseat the memory modules (see the *Service Manual* on the Dell Support website at [support.dell.com](http://support.dell.com)) to ensure that your computer is successfully communicating with the memory.

### Lockups and Software Problems

**If the computer does not start up** — Ensure that the power cable is firmly connected to the computer and to the electrical outlet.

**If a program stops responding** — End the program:

1. Press <Ctrl><Shift><Esc> simultaneously.
2. Click **Applications**.

3. Click the program that is no longer responding

4. Click **End Task**.

**If a program crashes repeatedly** — Check the software documentation. If necessary, uninstall and then reinstall the program.

 **NOTE:** Software usually includes installation instructions in its documentation or on the media (CD or DVD).

 **NOTE:** Your computer may or may not have an optical drive. Use an external optical drive or any external storage device for the procedures that involve media.

**If the computer stops responding** —

 **NOTICE:** You might lose data if you are unable to perform an operating system shutdown.

Turn the computer off. If you are unable to get a response by pressing a key on your keyboard or moving your mouse, press the power button for at least 8 to 10 seconds until the computer turns off and then restart your computer.

**If a program is designed for an earlier Microsoft® Windows® operating system** —

Run the Program Compatibility Wizard. The Program Compatibility Wizard configures a program so that it runs in an environment similar to non-Windows Vista operating system environments.

1. Click **Start**  → **Control Panel** → **Programs** → **Use an older program with this version of Windows**.

2. In the welcome screen, click **Next**.

3. Follow the instructions on the screen.

**If a solid blue screen appears** — Turn the computer off. If you are unable to get a response by pressing a key on your keyboard or moving your pointer or mouse, press and hold the power button for at least 8 to 10 seconds until the computer turns off. Then restart your computer.

## Solving Problems

### **If you have other software problems** —

- Back up your files immediately.
- Use a virus-scanning program to check the hard drive or CDs.
- Save and close any open files or programs and shut down your computer through the **Start**  menu.
- Check the software documentation or contact the software manufacturer for troubleshooting information:
  - Ensure that the program is compatible with the operating system installed on your computer.
  - Ensure that your computer meets the minimum hardware requirements needed to run the software. See the software documentation for information.
  - Ensure that the program is installed and configured properly.

- Verify that the device drivers do not conflict with the program.
- If necessary, uninstall and then reinstall the program.

**If a solid blue screen appears** — Turn the computer off. If you are unable to get a response by pressing a key on your keyboard or moving your pointer using the touch pad or mouse, press and hold the power button for at least 8 to 10 seconds until the computer turns off and then restart your computer.



# Using Support Tools

 **NOTE:** The instructions in this section are for computers with Windows Vista operating system installed.

## Dell Support Center

The **Dell Support Center** helps you find the service, support, and system-specific information you need. For more information about **Dell Support Center** and available support tools, click the **Services** tab at [support.dell.com](http://support.dell.com).



Click the  icon in the taskbar to run the application. The home page provides links to access:

- Self Help (Troubleshooting, Security, System Performance, Network/Internet, Backup/Recovery, and Windows operating system)
- Alerts (technical support alerts relevant to your computer)

- Assistance from Dell (Technical Support with DellConnect™, Customer Service, Training and Tutorials, How-To Help with Dell on Call, and Online Scan with PCCheckUp)
- About Your System (System Documentation, Warranty Information, System Information, Upgrades & Accessories)

The top of the **Dell Support Center** home page displays your computer's model number along with its service tag and express service code.

For more information about the **Dell Support Center**, see the *Dell Technology Guide* on your hard drive or on the Dell Support website at [support.dell.com](http://support.dell.com).

### System Messages

If your computer has an issue or error, it may display a System Message that will help you identify the cause and action needed to resolve the issue.

 **NOTE:** If the message you received is not listed in the following examples, see the documentation for either the operating system or the program that was running when the message appeared. Alternatively you could see the *Service Manual* on the Dell Support website at [support.dell.com](http://support.dell.com) or see “Contacting Dell” on page 34 for assistance.

**Alert! Previous attempts at booting this system have failed at checkpoint [nnnn]. For help in resolving this problem, please note this checkpoint and contact Dell Technical Support** — The computer failed to complete the boot routine three consecutive times for the same error see “Contacting Dell” on page 34 for assistance.

**CMOS checksum error** — Possible motherboard failure or RTC battery low. Replace the battery. See the *Service Manual* on the Dell Support website at [support.dell.com](http://support.dell.com) or see “Contacting Dell” on page 34 for assistance.

**Hard-disk (HDD) drive failure** — Possible hard disk drive failure during HDD POST, see “Contacting Dell” on page 34 for assistance.

**Hard-disk (HDD) drive read failure** — Possible hard disk drive failure during HDD boot test see “Contacting Dell” on page 34 for assistance.

**Keyboard failure** — Keyboard failure or loose cable.

**No boot device available** — No bootable partition on hard disk drive, the hard disk drive connector is loose, or no bootable device exists.

- If the hard drive is your boot device, ensure that the connector is connected and that the drive is installed properly and partitioned as a boot device.

- Enter system setup and ensure that the boot sequence information is correct (see the *Service Manual* on the Dell Support website at [support.dell.com](http://support.dell.com)).

**No timer tick interrupt** — A chip on the system board might be malfunctioning or motherboard failure (see the *Service Manual* on the Dell Support website at [support.dell.com](http://support.dell.com)).

**USB over current error** — Disconnect the USB device. Your USB device needs more power for it to function properly. Use an external power source to connect the USB device, or if your device has two USB cables, connect both of them.

**NOTICE - Hard Drive SELF MONITORING SYSTEM has reported that a parameter has exceeded its normal operating range. Dell recommends that you back up your data regularly. A parameter out of range may or may not indicate a potential hard drive problem** — S.M.A.R.T error, possible hard disk drive failure. (see “Contacting Dell” on page 34 for assistance).

## Hardware Troubleshooter

If a device is either not detected during the operating system setup or is detected but incorrectly configured, you can use the **Hardware Troubleshooter** to resolve the incompatibility.

To start the Hardware Troubleshooter:

1. Click **Start**  → **Help and Support**.
2. Type `hardware troubleshooter` in the search field and press <Enter> to start the search.
3. In the search results, select the option that best describes the problem and follow the remaining troubleshooting steps.

### Dell Diagnostics

If you experience a problem with your computer, perform the checks in “Lockups and Software Problems” on page 20 and run the Dell Diagnostics before you contact Dell for technical assistance.

It is recommended that you print these procedures before you begin.

 **NOTICE:** Dell Diagnostics works only on Dell computers.

 **NOTE:** The *Drivers and Utilities* media is optional and may not ship with your computer.

See the System Setup section in the *Service Manual* to review your computer’s configuration information, and ensure that the device that you want to test displays in the system setup program and is active.

Start the Dell Diagnostics from your hard drive or from the *Drivers and Utilities* media.

### Starting Dell Diagnostics From Your Hard Drive

The Dell Diagnostics is located on a hidden diagnostic utility partition on your hard drive.

 **NOTE:** If your computer cannot display a screen image, see “Contacting Dell” on page 34.

1. Ensure that the computer is connected to an electrical outlet that is known to be working properly.
2. Turn on (or restart) your computer.
3. When the DELL™ logo appears, press <F12> immediately. Select **Diagnostics** from the boot menu and press <Enter>.

 **NOTE:** If you wait too long and the operating system logo appears, continue to wait until you see the Microsoft® Windows® desktop; then, shut down your computer and try again.

 **NOTE:** If you see a message stating that no diagnostics utility partition has been found, run the Dell Diagnostics from the *Drivers and Utilities* media.

4. Press any key to start the Dell Diagnostics from the diagnostics utility partition on your hard drive.

### Starting Dell Diagnostics From the Drivers and Utilities Media

 **NOTE:** Your computer may or may not have an optical drive. Use an external optical drive or any external storage device for the procedures that involves media.

1. Insert the *Drivers and Utilities* media.
2. Shut down and restart the computer. When the DELL logo appears, press <F12> immediately.

 **NOTE:** If you wait too long and the operating system logo appears, continue to wait until you see the Microsoft® Windows® desktop; then, shut down your computer and try again.

 **NOTE:** The next steps change the boot sequence for one time only. On the next start-up, the computer boots according to the devices specified in the system setup program.

3. When the boot device list appears, highlight **CD/DVD/CD-RW** and press <Enter>.
4. Select the **Boot from CD-ROM** option from the menu that appears and press <Enter>.
5. Type 1 to start the CD menu and press <Enter> to proceed.
6. Select **Run the 32 Bit Dell Diagnostics** from the numbered list. If multiple versions are listed, select the version appropriate for your computer.
7. When the Dell Diagnostics **Main Menu** appears, select the test you want to run.

# Restoring Your Operating System

If you received an Operating System media with your computer, you can use it to restore your operating system. However, using the Operating System media also deletes all data on the hard drive.

## Windows Operating System Reinstallation

### Before you Begin

If you are considering reinstalling the Windows operating system to correct a problem with a newly installed driver, first try using Windows Device Driver Rollback.

- ➔ **NOTICE:** Before performing the installation, back up all data files.

To reinstall Windows, you need the following items:

- *Dell Operating System* media
- *Dell Drivers and Utilities* media

 **NOTE:** The *Dell Drivers and Utilities* media contains drivers that were installed during the assembly of the computer. Use the *Dell Drivers and Utilities* media to load any required drivers. Depending on the region from which you ordered your computer, or whether you requested the media, the *Dell Drivers and Utilities* media and *Operating System* media may not ship with your computer.

## Reinstalling Windows Vista

The reinstallation process can take 1 to 2 hours to complete. After you reinstall the operating system, you must also reinstall the device drivers, virus protection program, and other software.

1. Save and close any open files and exit any open programs.
2. Insert the *Operating System* disc.
3. Click **Exit** if the **Install Windows** message appears.
4. Restart the computer.
5. When the DELL logo appears, press <F12> immediately.

 **NOTE:** If you wait too long and the operating system logo appears, continue to wait until you see the Microsoft® Windows® desktop; then, shut down your computer and try again.

 **NOTE:** The next steps change the boot sequence for one time only. On the next start-up, the computer boots according to the devices specified in the system setup program.

6. When the boot device list appears, highlight **CD/DVD/CD-RW Drive** and press <Enter>.
7. Press any key to **Boot from CD-ROM**. Follow the instructions on the screen to complete the installation.

# Getting Help

If you experience a problem with your computer, you can complete the following steps to diagnose and troubleshoot the problem:

1. See “Solving Problems” on page 18 for information and procedures that pertain to the problem your computer is experiencing.
2. See “Dell Diagnostics” on page 25 for procedures on how to run Dell Diagnostics.
3. Fill out the “Diagnostic Checklist” on page 33.
4. Use Dell’s extensive suite of online services available at Dell Support ([support.dell.com](http://support.dell.com)) for help with installation and troubleshooting procedures. See “Online Services” on page 31 for a more extensive list of Dell Support online.
5. If the preceding steps have not resolved the problem, see “Before You Call” on page 33 and then “Contacting Dell” on page 34.

 **NOTE:** Call Dell Support from a telephone near or at the computer so that the support staff can assist you with any necessary procedures.

 **NOTE:** Dell’s Express Service Code system may not be available in all countries.

When prompted by Dell’s automated telephone system, enter your Express Service Code to route the call directly to the proper support personnel. If you do not have an Express Service Code, open the **Dell Accessories** folder, double-click the **Express Service Code** icon, and follow the directions.

 **NOTE:** Some of the services mentioned below are not always available in all locations outside the continental U.S. Call your local Dell representative for information on availability.



## Technical Support and Customer Service

Dell's support service is available to answer your questions about Dell hardware. Our support staff use computer-based diagnostics to provide fast, accurate answers.

To contact Dell's support service, see "Before You Call" on page 33 and then see the contact information for your region or go to **support.dell.com**.

## Online Services

You can learn about Dell products and services on the following websites:

- **www.dell.com**
- **www.dell.com/ap** (Asian/Pacific countries only)
- **www.dell.com/jp** (Japan only)
- **www.euro.dell.com** (Europe only)

- **www.dell.com/la** (Latin American and Caribbean countries)
- **www.dell.ca** (Canada only)

You can access Dell Support through the following websites and e-mail addresses:

Dell Support websites

- **support.dell.com**
- **support.jp.dell.com** (Japan only)
- **support.euro.dell.com** (Europe only)
- **supportapj.dell.com** (Asia Pacific only)

Dell Support e-mail addresses

- **mobile\_support@us.dell.com**
- **support@us.dell.com**
- **la-techsupport@dell.com** (Latin America and Caribbean countries only)
- **apsupport@dell.com** (Asian/Pacific countries only)

## Getting Help

Dell Marketing and Sales e-mail addresses

- **apmarketing@dell.com** (Asian/Pacific countries only)
- **sales\_canada@dell.com** (Canada only)

Anonymous file transfer protocol (FTP)

- **ftp.dell.com**

Log in as user: `anonymous`, and use your e-mail address as your password.

## AutoTech Service

Dell's automated support service—AutoTech—provides recorded answers to the questions most frequently asked by Dell customers about their portable and desktop computers.

When you call AutoTech, use your touch-tone telephone to select the subjects that correspond to your questions. For instructions on accessing the telephone number to call your region, see “Contacting Dell” on page 34.

## Automated Order-Status Service

To check on the status of any Dell products that you have ordered, you can go to **support.dell.com**, or you can call the automated order-status service. A recording prompts you for the information needed to locate and report on your order. For the telephone number to call your region, see “Contacting Dell” on page 34 for problems with your order.

If you have a problem with your order, such as missing parts, wrong parts, or incorrect billing, contact Dell for customer assistance. Have your invoice or packing slip handy when you call. For the telephone number to call for your region, see “Contacting Dell” on page 34.

## Product Information

If you need information about additional products available from Dell, or if you would like to place an order, visit the Dell website at **www.dell.com**. For the telephone number to call for your region or to speak to a sales specialist, see “Contacting Dell” on page 34.

## Before You Call

 **NOTE:** Have your Express Service Code ready when you call. The code helps Dell's automated-support telephone system direct your call more efficiently. You may also be asked for your Service Tag (located on the back or bottom of your computer).

Remember to fill out the following Diagnostics Checklist. If possible, turn on your computer before you call Dell for assistance and call from a telephone at or near the computer. You may be asked to type some commands at the keyboard, relay detailed information during operations, or try other troubleshooting steps possible only at the computer itself. Ensure that the computer documentation is available.

## Diagnostic Checklist

- Name:
- Date:
- Address:
- Phone number:
- Service Tag (bar code on the back or bottom of the computer):
- Express Service Code:
- Return Material Authorization Number (if provided by Dell support technician):
- Operating system and version:
- Devices:
- Expansion cards:
- Are you connected to a network? Yes /No
- Network, version, and network adapter:
- Programs and versions:

## Getting Help

See your operating system documentation to determine the contents of the computer's start-up files. If the computer is connected to a printer, print each file. Otherwise, record the contents of each file before calling Dell.

- Error message, beep code, or diagnostic code:
- Description of problem and troubleshooting procedures you performed:

## Contacting Dell

 **NOTE:** If you do not have an active Internet connection, you can find contact information on your purchase invoice, packing slip, bill, or Dell product catalog.

Dell provides several online and telephone-based support and service options. Availability varies by country and product, and some services may not be available in your area.

To contact Dell for sales, technical support, or customer service issues:

1. Visit **support.dell.com**.
2. Verify your country or region in the **Choose A Country/Region** drop-down menu at the bottom of the page.
3. Click **Contact Us** on the left side of the page.
4. Select the appropriate service or support link based on your need.
5. Choose the method of contacting Dell that is convenient for you.



# Finding More Information and Resources

**If you need to:****See:**

---

reinstall your operating system.

your Operating System media.

---

run a diagnostic program for your computer, reinstall desktop system software, or update drivers for your computer, and readme files.

the *Drivers and Utilities* media.



**NOTE:** Drivers and documentation updates can be found on the Dell™ Support website at **support.dell.com**.

---

learn more about your operating system, maintaining peripherals, RAID, Internet, Bluetooth®, networking, and e-mail.

the *Dell Technology Guide* installed on your hard drive.

---

upgrade your computer with new or additional memory, or a new hard drive.

the *Service Manual* on the Dell Support website at **support.dell.com**

reinstall or replace a worn or defective part.



**NOTE:** In some countries, opening and replacing parts of your computer may void your warranty. Check your warranty and return policies before working inside your computer.

---

### If you need to:

---

find safety best practices information for your computer

review Warranty information, Terms and Conditions (U.S. only), Safety instructions, Regulatory information, Ergonomics information, and End User License Agreement.

---

find your Service tag/Express Service Code— You must use the service tag to identify your computer on **support.dell.com** or to contact technical support.

---

find drivers and downloads.

access technical support and product help.

check on your order status for new purchases.

find solutions and answers to common questions.

locate information for last-minute updates about technical changes to your computer or advanced technical-reference material for technicians or experienced users.

---

### See:

---

the safety and regulatory documents that shipped with your computer and also see the Regulatory Compliance Homepage at **www.dell.com/regulatory\_compliance**.

---

the back or bottom of your computer.

---

the Dell™ Support website at **support.dell.com**.

# Basic Specifications

## System Model

Dell Inspiron 1410

This section provides basic information that you may need when setting up, updating drivers for, and upgrading your computer. For more detailed specifications, see the *Service Manual* on the Dell Support website at [support.dell.com](http://support.dell.com).



**NOTE:** Offerings may vary by region.

For more information regarding the configuration of your computer, click **Start** → **Help and Support** and select the option to view information about your computer.

## Processor

Type

Intel® Pentium™  
Dual-Core  
T2390 and Intel®  
Celeron® 560

L1 cache

32 KB per  
instruction, 32 KB  
data cache per  
core

L2 cache

512 KB, 1 MB, 2  
MB, or 4 MB

External bus frequency

667 MHz and 800  
MHz



**Memory**

---

Memory module connector	two user-accessible SODIMM sockets
Memory module capacities	512 MB, 1 GB, 2 GB 4-GB capable
Memory type	DDR2 SODIMM
Minimum memory	512 MB
Maximum memory	4 GB

 **NOTE:** For instructions on upgrading your memory, see the *Service Manual* on the Dell Support website at [support.dell.com](http://support.dell.com).

**Computer Information**

---

System Chipset	Intel GM965 Express/ ICH8M
PCI Bus	internal
Data bus width	64 bits
DRAM bus width	dual-channel (2) 64-bit buses
Processor address bus width	36 bits
Flash EPROM	2 MB
Graphics Bus	internal

## Basic Specifications

### Communications

---

Modem type	v.92 Data/Fax MDC Modem
Modem controller	softmodem
Interface	HDA Bus
Network adapter	10/100 Ethernet LAN on system board
Wireless	internal WLAN and Bluetooth® wireless support (if optional cards are purchased)

### 3-in-1 Media Card Reader

---

3-in-1 media memory card controller	Ricoh 5C847
3-in-1 media memory card connector	3-in-1 combo card controller
Cards supported	SD/SDIO/MMC

### Video

---

Video type	integrated on system board, hardware accelerated
Data bus	integrated video
Video controller	Intel Extreme Graphics
Video memory	up to 128 MB

**Audio**

Audio type	two-channel high definition audio (Azalia)
Audio controller	Conexant CX20561-12Z
Stereo conversion	24-bit (analog-to-digital and digital-to-analog)
Internal Interface	high-definition audio (Azalia) codec
External Interface	microphone-in connector, stereo headphones/speakers connector
Speaker	one 4-ohm speaker
Internal speaker amplifier	2-W channel into 4 ohms
Volume controls	program menus

**Ports and Connectors**

Audio	microphone connector, stereo headphone/speakers connector
Mini-Card	one PCI-E Mini-Card slot
Modem	RJ-11 port
Network adapter	RJ-45 port
USB	two 4-pin USB 2.0-compliant connectors
Video	15-hole connector
IEEE 1394	4-pin mini

## Basic Specifications

### Display

---

Type (active-matrix TFT)	WXGA
Active area (X/Y)	303.36x 189.6 mm
<i>Dimensions:</i>	
Height	206 mm (8.11 inches)
Width	320 mm (12.6 inches)
Diagonal	358.14 mm (14.1 inches)
Operating angle	0° (closed) to 165°
<i>Viewing Angles:</i>	
WXGA Horizontal	40/40°
WXGA Vertical	15/30°
Pixel pitch	0.2373 mm

### Display

---

WXGA Power Consumption (panel with backlight) (typical)	6.2 W (max) with no inverter losses
---	-------------------------------------

### Touchpad

---

X/Y position resolution (graphics table mode)	240 cpi
<i>Size:</i>	
Width	73.0-mm (2.9-inch sensor-active area)
Height	42.9-mm (1.7-inch rectangle)

**Keyboard**

Number of keys	86 (U.S. and Canada); 87 (Europe); 90 (Japan)
Layout	QWERTY/AZERTY/ Kanji

**Battery**

Type	6-cell “smart” lithium ion 4-cell “smart” lithium ion
Depth	53.4 mm (2.1 inches)
Height	20 mm (0.78 inch)
Width	206.2 mm (8.12 inches)
Weight	0.31 kg (0.68 lb) (6-cell) 0.23 kg (0.50 lb) (4-cell)

**AC Adapter**

Input voltage	100–240 VAC
Input current (maximum)	1.5 A
Input frequency	50–60 Hz
Output power	65 W
Output current	4.34 A (maximum at 4-second pulse); 3.34 A (continuous)
Rated output voltage	19.5 +/-1.0 VDC
<i>Dimensions:</i>	
Height	28.2 mm (1.11 inches)
Width	57.9 mm (2.28 inches)
Depth	137.2 mm (5.4 inches)
Weight (with cables)	0.15 kg (0.33 lb)

## Basic Specifications

### Physical

---

Height	31.1 to 35.6 mm (1.2 to 1.4 inches)
Width	340 mm (13.39 inches)
Depth	250 mm (9.85 inches)
Weight (with 4-cell battery)	2.17 kg (4.78 lb)
Weight (with 6-cell battery)	2.26 kg (4.98 lb)

### Computer Environment

---

#### *Temperature range:*

Operating	0° to 35°C (32° to 95°F)
Storage	-40° to 65°C (-40° to 149°F)

### Computer Environment

---

#### *Relative humidity (maximum):*

Operating	10% to 90% (noncondensing)
Storage	5% to 95% (noncondensing)

#### *Maximum vibration (using a random-vibration spectrum that simulates user environment):*

Operating	0.66 GRMS
Storage	1.3 GRMS

#### *Maximum shock (measured with hard drive in head-parked position and a 2-ms half-sine pulse):*

Operating	110 G
Storage	163 G
Airborne contaminant level	G2 or lower as defined by ISA-S71.04-1985

# Index

## A

AC adapter

size and weight **43**

airflow, allowing **5**

AutoTech **32**

## B

backups

creating **17**

## C

calling Dell **33**

chipset **39**

computer, setting up **5**

connect(ing)

to the Internet **6**

conserving energy **16**

customer service **31**

customizing

your energy settings **16**

## D

damage, avoiding **5**

data, backing up **17**

Dell Support Center **23**

Dell support website **37**

Dell Technology Guide

for further information **36**

Diagnostic Checklist **33**

drivers and downloads **37**

## E

e-mail addresses

for technical support **31**

## Index

energy

conserving **16**

expansion bus **40**

## F

finding more information **36**

FTP login, anonymous **32**

## H

hardware problems

diagnosing **25**

Hardware Troubleshooter **25**

help

getting assistance and support **30**

## I

Internet connection **6**

ISP

Internet Service Provider **7**

## M

memory problems

solving **20**

memory support **39**

## N

network connection

fixing **18**

## O

order status **32**

## P

power problems, solving **19**

power strips, using **5**

problems, solving **18**

processor **38**

products

information and purchasing **32**



**R**

reinstalling

Windows **28**

resources, finding more **36**

**S**

setup, before you begin **5**

software features **16**

software problems **20**

solving problems **18**

specifications **38**

support e-mail addresses **31**

support sites

worldwide **31**

System Messages **24**

system reinstall options **28**

**T**

technical support **31**

**V**

ventilation, ensuring **5**

**W**

Windows, reinstalling **28**

Windows Vista® **6**

Program Compatibility Wizard **21**

reinstalling **29**

setup **6**

wired network

network cable, connecting **6**

wireless network connection **18**





Printed in China.

Printed on recycled paper.

[www.dell.com](http://www.dell.com) | [support.dell.com](http://support.dell.com)



OY727HA01